

# Angelcare®

FOR YOUR PEACE OF MIND

## OWNER'S MANUAL

VIDEO & SOUND MONITOR

Model AC1120



DON'T FORGET

### IMPORTANT ADVICE FOR INITIAL SETUP



#### Batteries

Insert the enclosed rechargeable batteries into the Parent Unit. If inserted incorrectly the Parent Unit will not charge when placed in the charging cradle. The battery icon will flash briefly on the Parent Unit screen to indicate charging.



#### Cord Safety

Ensure the Nursery Unit is at least 1 metre away from your baby's cot. The Sensor Pad cord must always be kept out of reach of baby and secured using the cord cover kit provided.

**PLEASE FOLLOW THE INSTRUCTIONS CAREFULLY FOR CORRECT SETUP**

Please **DO NOT** return this product to the store. For assistance please contact our helpline on **0345 009 1789** or email [helpline@babyhelpline.co.uk](mailto:helpline@babyhelpline.co.uk)  
Mon - Fri 10am - 4pm, excluding bank holidays.

## TABLE OF CONTENTS

 WARNINGS .....	3
AC1120 SETUP REQUIREMENTS.....	7
STEP 1 - Charging the Parent Unit (10 hours).....	8
STEP 2 - Setting up the Nursery Unit.....	9
STEP 3 - Turning on your monitor .....	10
STEP 4 - Testing and getting to know your monitor.....	11
STEP 5 - Activating and deactivating additional functions .....	14
TROUBLESHOOTING.....	20
LIMITED WARRANTY .....	21
TECHNICAL SPECIFICATIONS.....	22

## OWNER'S MANUAL

KEEP YOUR OWNER'S MANUAL FOR FUTURE REFERENCE.

PLEASE READ THE WARNINGS AND INSTRUCTIONS CAREFULLY BEFORE ASSEMBLING & USING THE PRODUCT.

FAILURE TO FOLLOW THE WARNINGS AND THE INSTRUCTIONS COULD RESULT IN SERIOUS INJURY OR DEATH OR DAMAGES TO THE PRODUCT.

### WARNING

Adult assembly required.  
Keep small parts away from children when assembling.

We, at Angelcare®, stand behind all of our products.  
If you are not completely satisfied or have any questions,  
**United States and Canada:** please contact us at: [angelcare@cdecinc.ca](mailto:angelcare@cdecinc.ca)  
**Other countries:** please contact your local distributor.



This Angelcare Monitor is a Personal Care Product. Please DO NOT return this to the store where you purchased it from. If you have any questions or require assistance please call the Angelcare Helpline on 0345 009 1789 or email [helpline@babyhelpline.co.uk](mailto:helpline@babyhelpline.co.uk).

The Baby Helpline is open Monday to Friday, 10am to 4pm. The helpline is closed on bank holidays.

For additional FAQs and to download instruction manuals visit; [www.angelcare.co.uk](http://www.angelcare.co.uk).

# ⚠ WARNINGS

**1.** THIS PRODUCT CANNOT REPLACE RESPONSIBLE ADULT SUPERVISION. This product is designed to aid in the monitoring of your child. When using the monitor, you must still provide the supervision necessary for the continued safety of your child.

**2.** WARNING Strangulation Hazard — Children have STRANGLED in cords. Keep adapter cords out of the reach of children (more than 1 m away).



**3.** Never use extension cords with AC adapters. ONLY use the AC adapters provided.

**4.** When an AC Adapter is plugged into an electrical outlet, DO NOT touch the exposed end.

**5.** ALWAYS be sure that both the transmitter and receiver are working properly and are within range of each other. Test monitor before first use, periodically and when changing location of the Nursery Unit.

**6.** DO NOT use monitor near water (such as bath tub, sink, etc.).



**7.** Keep monitor AWAY from heat sources (such as stoves, radiators, etc.).

**8.** ALWAYS place both the Nursery Unit and the Parent Unit on a flat surface in an upright position and allow for proper ventilation. DO NOT place on sofas, cushions, beds, etc. which may block ventilation.

**9.** This product is NOT a toy. DO NOT allow children to play with it.

**10.** This product contains small parts. Adult assembly required. Exercise care when unpacking and assembling the product and keep small parts away from children.

**11.** When using the monitor, the room temperature should be between 10°C and 40°C.

## ⚠ BATTERY WARNING

**12.** Use ONLY AAA RECHARGEABLE batteries for the Parent Unit. DO NOT mix old and new batteries. DO NOT mix alkaline, standard or rechargeable batteries. Insert batteries with correct polarity. DO NOT short-circuit supply terminals. ONLY use the recommended batteries or equivalent (volts and size) and the correct adapter. Remove batteries when product is stored for long periods of time or when batteries are exhausted. Dispose exhausted batteries properly. DO NOT recharge non-rechargeable batteries. Rechargeable batteries are ONLY to be charged under adult supervision. Keep all batteries away from children.

### 13. IMPORTANT SAFETY INSTRUCTIONS

**13.1** Read these instructions - All the safety instructions should be read before the product is operated.

**13.2** Keep these instructions. The safety and operating instructions should be retained for future reference.

**13.3** Heed all warnings - All warnings on the product and in the operating instructions should be adhered to.

**13.4** Follow all instructions - All operating and use instructions should be followed.

**13.5** Water and moisture - DO NOT use this apparatus near water. For example, near a bath tub, wash bowl, kitchen sink, laundry tub, in a wet environment or near a swimming pool and the like. Care should be taken so that objects DO NOT fall onto units and that liquids are not spilled into either unit through its openings.

**13.6** Cleaning - Disconnect all units before cleaning. DO NOT immerse in water any part of the Nursery Unit or the Parent Unit. Clean only with dry cloth.

**13.7** Ventilation - DO NOT block any ventilation openings. Allow for proper ventilation when units are in use. DO NOT cover the Nursery Unit or the Parent Unit with any object such as a blanket. DO NOT place it in a drawer or in any location which would muffle the sound or interfere with the normal flow of air.

**13.8** Heat sources - DO NOT install near any heat sources such as radiators, heat registers, stoves, TVs or other apparatus (including amplifiers) that produce heat. Heat can damage the case or electrical parts.

**13.9** Power cord protection - Protect the adapter's power cord from being walked on or pinched by furniture or other items - Power supply cords should be routed so that they are not likely to be walked on or pinched by items upon or against them, paying particular attention to cords and plugs, convenience receptacle, and the point where they exit from the product.

**13.10** Accessories - Only use attachments/accessories specified by the manufacturer. DO NOT place this product on an unstable cart, stand, tripod, bracket or table. The product may fall, causing serious injury to a child or adult and serious damage to the product. Use ONLY with a cart, stand,

tripod, bracket or table recommended by the manufacturer or sold with the product. Any mounting of the product should follow the manufacturer's instructions.

**13.11** Unplug this appliance during lightning storms or when not used for long periods of time.

**13.12** Servicing - DO NOT attempt to service this product yourself as opening or removing covers (except battery doors) may expose you to dangerous voltage or other hazards.

**13.13** Replacement parts - When replacement parts are required, be sure the replacement parts specified by the manufacturer have the same characteristic as the original part. Unauthorized substitution may result in fire, electric shock or other hazards.

**13.14** Usage - This baby monitor is intended as an aid. It is NOT a substitute for responsible and proper adult supervision and should not be used as such. Use this appliance ONLY for its intended use as described in this manual.

**13.15** Power Sources - Operate this product only from the type of power source indicated on the type plate of the adaptor. If you are unsure of the type of power supply to your home, consult your dealer or local power company.

**13.16** Overloading - DO NOT overload wall outlets, extension cords or integral convenience receptacles as this can result in a risk of fire or electric shock.

**13.17** Object and Liquid Entry - NEVER push objects of any kind into this product through casing slots as they may touch dangerous voltage points or short out parts that could result in a risk of fire or electric shock. NEVER spill liquid of any kind on the product.

**13.18** Antenna - The antenna used for this transmitter must be installed to provide a separation distance of at least 20 cm from all persons and must not be collocated or operating in conjunction with any other antenna or transmitter.

**13.19** Power Lines - An outside antenna system should NOT be located in the vicinity of overhead power lines or other electric light or power circuit, or where it can fall into such power lines or circuits as contact with them may be fatal.



**13.20** WARNING Strangulation Hazard — Children have STRANGLED in cords. Keep adapter cords out of the reach of children (more than 1 m away).

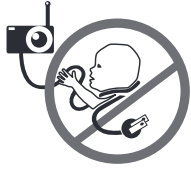

**13.21** Interference - This monitor uses public airwaves to transmit signals. The Parent Unit may pick up signals or interference from other nursery monitors in your area. Your monitor may even be picked up by other households. To protect your privacy, make sure both units are turned OFF when not in use.

#### **14. IMPORTANT SAFETY INSTRUCTIONS RELATED TO USE OF BATTERIES**

**14.1** Use ONLY the type and size of batteries specified in the owner's manual. There is a risk of explosion if batteries are replaced with an incorrect type.

**14.2** Use ONLY AAA rechargeable batteries and/or the AC Adapters provided for the Parent Unit. You must use only rechargeable batteries in the Parent Unit. DO NOT use alkaline batteries or you will severely damage the unit.

**14.3** Charge the batteries for 10 hours prior to first use. Be sure to have the monitor in the OFF position during this period, ONLY use the AC Adapters included with your monitor.

**14.4** DO NOT use these adapters with any other equipments.

**14.5** When unplugging the AC Adapter from the Nursery Unit, be sure it is switched to the OFF position. If it isn't, the unit will revert to battery mode if batteries are installed.

**14.6** DO NOT use rechargeable batteries in the Nursery Unit. Use alkaline batteries ONLY.

**14.7** DO NOT dispose batteries in fire. They may explode. Check with local regulations for possible special disposal instructions.

**14.8** Exercise care in handling batteries in order not to short out the batteries with conducting materials such as rings, bracelets and keys. Overcharging, short circuiting, reverse charging, mutilation, or incineration of batteries must be avoided to prevent one or more of the following occurrences: release of toxic materials, release of hydrogen and/or oxygen gas and rise in surface temperature.

**14.9** DO NOT attempt to recharge batteries provided with or identified for use with this product that are not intended to be charged. The batteries may leak corrosive electrolyte or explode.

**14.10** DO NOT attempt to rejuvenate the batteries provided with or identified for use with this product by heating them. Sudden release of battery electrolyte may occur, causing burns or irritation to eyes or skin.

**14.11** If and when necessary, the batteries must be replaced with identical new ones or equivalent (volts and size). If a battery to be replaced is connected with other batteries in series, replace the other batteries at the same time as well. DO NOT mix old and new batteries.

**14.12** Reverse polarity installation of the batteries in the end product must be avoided. Reverse insertion of batteries can cause charging, and that may result in leakage or explosion.

**14.13** Remove batteries from this product if you store the product over 30 days because the batteries could leak and damage the product.

**14.14** Discard 'dead' batteries as soon as possible since 'dead' batteries are more likely to leak in a product. If a battery has leaked or vented, it should be replaced immediately using protective gloves.

**14.15** DO NOT store this product, or the batteries provided with or identified for use with this product, in high-temperature areas.

## 15. WARNING

### (North America Only)

**15.1** Modifications not authorized by the manufacturer may void users authority to operate this device.

**15.2 NOTE:** This equipment has been tested and found to comply with part 15 of the FCC Rules and the Industry Canada licence-exempt RSS standard(s). These limits are designed to provide reasonable protection against harmful interference in a residential installation. This equipment generates, uses and can radiate radio frequency energy and, if not installed and used in accordance with the instructions, may cause harmful interference to radio communications.

**15.3** However, there is no guarantee that interference will not occur in a particular installation. If this equipment does cause harmful interference to radio or television reception, which can be determined by turning the equipment OFF and ON, the user is encouraged to try to correct the interference by one or more of the following measures:

- Reorient or relocate the receiving antenna.
- Increase the separation between the equipment and receiver.
- Connect the equipment into an outlet on a circuit different from that to which the receiver is connected.
- Consult the dealer or an experienced radio/TV technician for help.

**15.4** This device complies with the part 15 of the FCC Rules and the Industry Canada licence - exempt RSS standards(s). Operation is subject to the following two conditions:

- (1)** This device may not cause harmful interference, and
- (2)** This device must accept any interference received, including interference that may cause undesired operation.

### FCC AND IC REGULATIONS

#### RF radiation exposure statement

The Nursery Unit complies with FCC RF radiation exposure limits set forth for an uncontrolled environment. **Caution:** To maintain the compliance with the FCC's RF exposure guideline, install the Nursery Unit at least 20 cm from ALL persons. The transmitter of this device must not be co-located or operating in conjunction with any other antenna or transmitter.

#### Industry Canada

This product meets the applicable Industry Canada technical specifications.  
CAN ICES-3 (B)/NMB-3 (B)

# SETUP REQUIREMENTS

VIDEO & SOUND MONITOR

Model AC1120

EN

## INCLUDED:



Rechargeable Parent Unit



Nursery Unit



Charging Cradle



Belt Clip

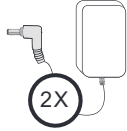

2 AC Adapters



3 Rechargeable AAA Batteries for Parent Unit

## WHAT YOU WILL NEED (NOT INCLUDED):

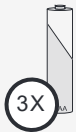

3 AAA Alkaline Batteries for Nursery Unit



Miniature Philips Screwdriver

## BABY'S ROOM:

### IMPORTANT

Install the Nursery Unit on a flat, stable surface facing the crib at a distance of at least **1 meter**. Make sure to plug the adapter to the socket outlet nearest to the equipment and that is easily accessible.

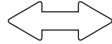
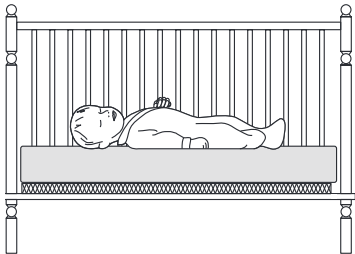

**IMPORTANT**  
Keep  
at least  
1 m

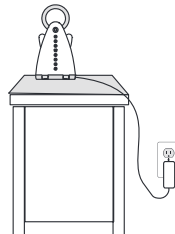

STEP 1 - CHARGING THE PARENT UNIT (10 HOURS)

**IMPORTANT**

Never use regular alkaline batteries in the Parent Unit they may explode.

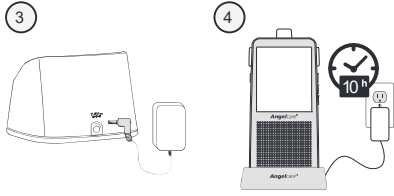
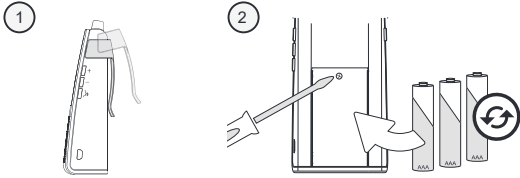

- 1) Remove the Belt Clip.
- 2) Remove the battery door and insert the Rechargeable Batteries (included).
- 3) Connect the AC Adapter to the Charging Cradle and into an electrical outlet.
- 4) Charge the unit for 10 continuous hours (or to test us).

**NOTE**

To optimize your battery performance please refer to Battery Guidelines in the Trouble Shooting section.

**PARENT UNIT**

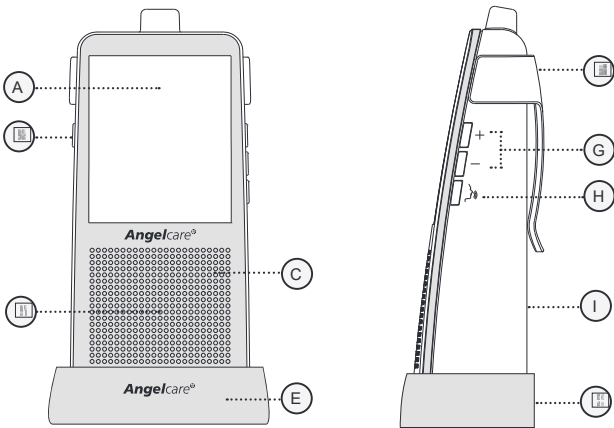

- A) Touchscreen
- POWER ON
- C) Microphone
- Speaker
- E) Charging Cradle
- Belt Clip
- G) Speaker
- Volume Buttons
- H) Talk Back Button
- I) Battery Door (not shown)
- AC Adapter Outlet (not shown)

Front Side

Left Side



**STEP 2 - SETTING UP THE NURSERY UNIT**

**E  
N**

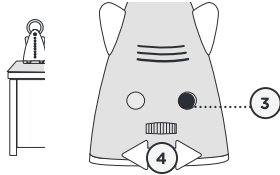
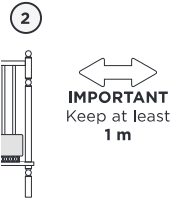
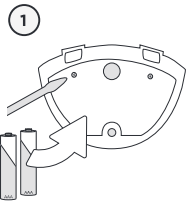

- 1) Remove the battery door and insert 3 AAA Alkaline Batteries (not included).
- 2) Place the Nursery Unit at a **minimum of 1 meter** away from the crib.
- 3) Connect the AC Adapter to the Nursery Unit and into an electrical outlet.
- 4) Direct the angle of the camera toward the crib using the rotating dial.

**NOTE:**

The batteries maintain power supply in case of power outage.

**NURSERY UNIT:**

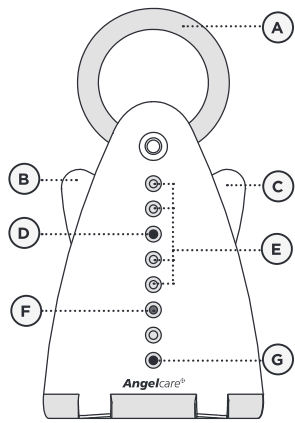

Front Side

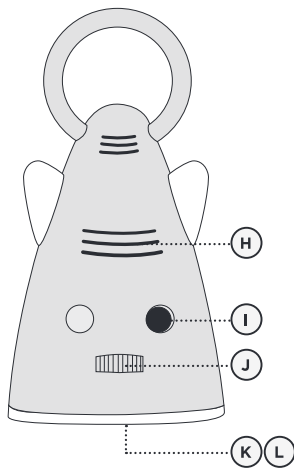

Back Side

- A) Night Light
- B) **POWER ON/OFF** (Left 'Wing')
- C) Night Light ON/OFF (Right 'Wing')
- D) Video Camera
- E) 4 Infrared LEDs (Night Vision Camera)
- F) Power Indicator (green)  
Low Battery Indicator (red)
- G) Microphone
- H) Speaker
- I) AC Adapter Outlet
- J) Rotating Dial for Camera Angle
- K) Battery Door (not shown)
- L) Tripod mount\* (not shown)

\* Nursery Unit may be installed on a tripod (not included).

## STEP 3 - TURNING ON YOUR MONITOR

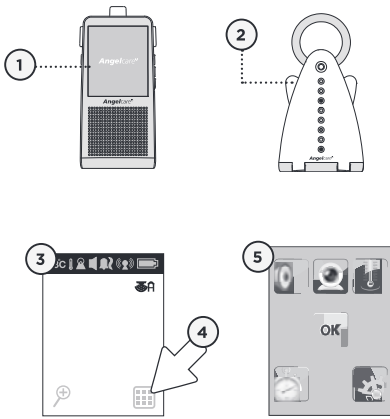

- 1) Press the Parent Unit **ON/OFF** button for 2 seconds until blue screen appears.
- 2) Push and hold the Nursery Unit **left 'wing'** button for 2 seconds.
- 3) The Parent Unit will display **Video mode** screen.
- 4) Press the **Menu** icon to access main menu.
- 5) The Parent Unit will display **Menu** mode.

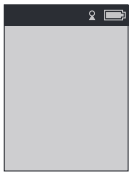

When Parent Unit is turned **ON** and Nursery Unit is **OFF**, Parent Unit will display **Disconnected** mode and will turn itself **OFF** after 60 seconds.



If there is a lost connection between the 2 units (refer to troubleshooting):

- The **Out-of-Range** icon will appear on the screen.
- The **Lost Connection** icon will appear on the indicator bar.

## INDICATION BAR IMPORTANT ICONS



**23°C Temperature icon:**  
Indicates room temperature

**Temperature Alarm icon:** Indicates Temperature Alarm is active

**Sound icon:** Indicates that Sound function is active

**Alarm icon:** Indicates selected alarm mode

Sound alarm

Sound alarm and vibration

Vibration only

**Connection icon:** Indicates the connection quality between the Parent Unit and the Nursery Unit.

Good connection

Poor connection

Lost connection

Out-of-Range

**Battery Level icon:**  
Indicates battery level

Empty

1/3 Full

2/3 Full

Full

## ⚠ WARNING

### STRANGULATION HAZARD.

Children have STRANGLED in cords.

- Keep adapter cords out of the reach of children (more than 1 m away).
- Because of the serious strangulation risk to infants and toddlers, parents and caregivers should never place the Nursery Unit within 1 meter of a crib.
- **NEVER** use extension cords with AC adapters. **ONLY** use the AC adapters provided. This product is not a toy. Never allow children to play with it.

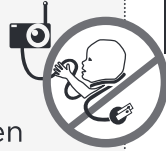

EN

## STEP 4 - TESTING AND GETTING TO KNOW YOUR MONITOR

The Angelcare® monitor can be used with the pre-program factory settings or you can also customise your settings to your preference.



All changes and adjustments made in the main menu and sub-menus will not be activated unless you confirm them by pressing the **OK** icon.

### IMPORTANT

When in menu or sub-menu modes, sound transmission between the Parent and the Nursery Units will be temporarily deactivated.

## 4.1 - SOUND

### TO ACTIVATE SOUND:

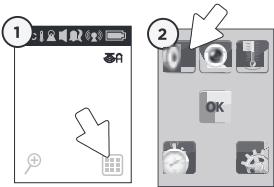

- 1) Press **Menu** icon to access main menu.
- 2) Press **Sound** icon to **activate** or **deactivate** sound.



- 3) Press **OK** icon to confirm.

#### TO TEST SOUND

Ask someone to speak into the Nursery Unit or place the unit near a radio to ensure that sound is being picked up.

#### IMPORTANT

To avoid feedback whistling, keep both units at least 1 meter apart.

#### IF YOU HEAR NO SOUND

- Check that both units are powered on.
- Check that both units are plugged into functioning electrical outlets.
- Check the batteries in both units. Replace or recharge them if necessary.
- Bring the Parent Unit closer to the Nursery Unit.
- Check on the top bar of the Parent Unit to see if the monitor is on "MUTE" instead of "MUTE".

#### ADJUST SOUND LEVEL

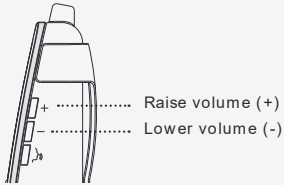

#### PUT IN SILENT/MUTE MODE

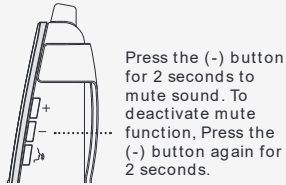

#### PUT IN DIALOGUE MODE

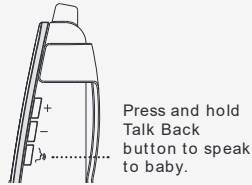

## 4.2 - BATTERIES

#### HOW TO CHECK THE BATTERIES

Unplug the adapters from both units.

- If the green light on the Nursery Unit does not show, replace the batteries.
- If the Parent Unit and its screen do not light up, recharge the batteries.

#### HOW TO CHARGE THE BATTERIES IN THE PARENT UNIT

Leave the Parent Unit in the charging cradle to fully charge the unit. Although the batteries at 100% capacity works normally, we recommend that you fully recharge them.

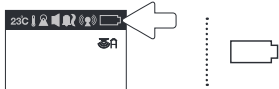
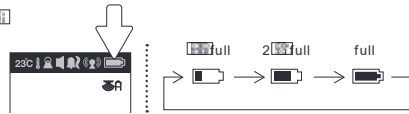









#### PARENT UNIT BATTERY ALARM

- Alarm activates when the batteries need to be recharged.
- Parent Unit will emit a beep sound every 30 seconds.
- Battery Alarm icon will show on LCD screen.

# YOU ARE NOW READY TO USE YOUR MONITOR

An Angelcare® monitor can be used straight from factory settings or you can also customise your settings to your preference.

## DEFAULT SETTINGS

-  Sound Mode: ON  
Speaker Volume: Level 3 (of 6)
-  Temperature Unit: Celcius  
Temperature Alarm: OFF  
Temperature Alarm Setting  
High Temperature Limit: Low  
Low Temperature Limit
-  VOX Mode: OFF  
VOX Level: Level 2 (of 4)
-  Timer: OFF
-  Alarm Mode: Sound alarm only
-  Video Camera: ON
-  Screen Saver Timer: OFF
-  Night View Mode: AU
-  Tone: ON



## IMPORTANT

- Test your monitor before first use.
- Test your monitor regularly to ensure it is functioning correctly.



All changes and adjustments made in the main menu and sub-menus will not be activated unless you confirm them by pressing the OK icon.

**IMPORTANT**  
When in the menu or sub-menu modes, sound transmission between the Parent Unit and the Nursery Unit will be temporarily deactivated.

5.1 VOICE ACTIVATION (VOX) OR CONTINUOUS SOUND MODE

Allows you to select your option on how you monitor sound

VOX (Voice activation) picks up sound based on the setting of the sensitivity level or Continuous sound monitoring is continuously on, picking up all sounds

TO ACTIVATE VOX MODE:

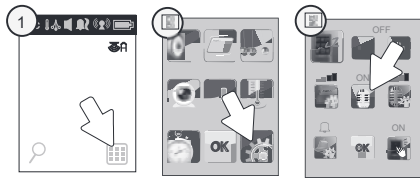

- 1) Press Menu icon to access the main menu.
- 2) Press icon to access sub-menu.
- 3) Press VOX icon to or the VOX function.

**NOTE:**  
 deactivating VOX the continuous setting is ON.

- 4) Press OK to confirm.



TO ADJUST THE VOX SENSITIVITY:

Allows you to determine the sound level needed to trigger sound transmission to the Parent Unit.

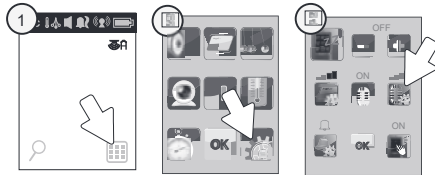

- 1) Press Menu icon to access the main menu.
- 2) Press icon to access sub-menu.
- 3) Press VOX icon sensitivity to choose sound sensitivity level to .
- 4) Press OK to confirm.



## 5. ALARM

Allows you to select your preferred alarm mode for the Parent Unit.

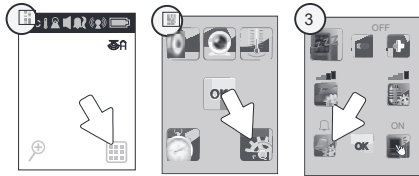

1 Press the Menu icon to access main menu.

2 Press the Settings icon to access sub menu.

3 Press the Alarm icon to change the alarm mode.

Press OK to confirm.



Sound alarm only



Sound alarm and vibration



Vibration only (the alarm will not sound on the Parent Unit but it will on Nursery Unit).



Alarm Mode icon shows in the top bar of the Parent Unit.

Sound alarm will replace Vibration mode when the Parent Unit is in its Charging Cradle.

### IMPORTANT

When in Settings mode no sound or alarms will transmit to the Parent Unit.

## 5.3 - THERMOMETER

TO CHANGE THE MEASUREMENT UNIT

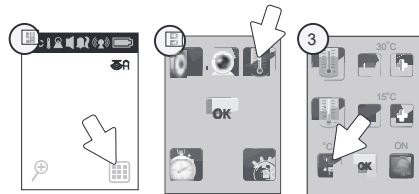

1 Press the Menu icon to access main menu.

2 Press the Temperature icon to access sub menu.

3 Press the °C icon to change from Celsius to Fahrenheit.

Press OK to confirm.



Celsius



Fahrenheit

TO ACTIVATE THE TEMPERATURE ALARM

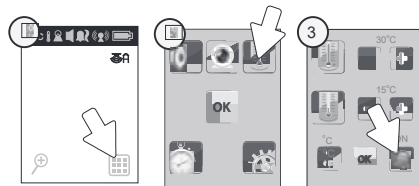

1 Press the Menu icon to access main menu.

2 Press the Temperature icon to access sub menu.

3 Press the Temperature Alarm icon to activate or deactivate temperature alarm.

Press OK icon to confirm.



Temperature Alarm icon:  
 Indicates temperature alarm is active.

TO SET THE TEMPERATURE RANGE:

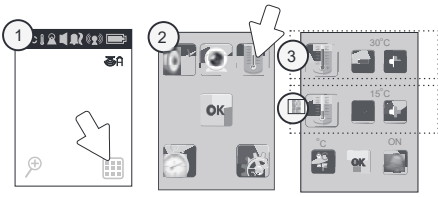

- 1) Press the Menu icon to access main menu.
- 2) Press the Temperature icon to access sub-menu.
- 3) Press (+ or -) to set maximum temperature range (15 to 32 °Celsius).
- Press (+ or -) to set minimum temperature range (5 to 20 °Celsius).
- Press OK icon to confirm.

The range between the minimum and maximum temperature must be at least 5 °C. Error tone will be heard if you try to set it up below this minimum level.



TEMPERATURE ALARM

- Alarm activates when temperature reaches maximum or minimum set temperature.
- Parent Unit will emit consecutive beeps for 15 seconds.
- Temperature Alarm icon will show on screen.



How to turn Auto function ON or OFF

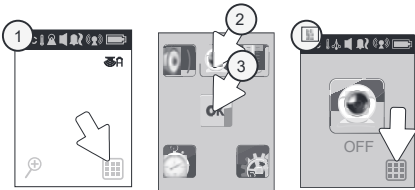

- 1) Press the Menu icon to access main menu.
- 2) Press the Auto icon to activate or deactivate the Auto function.
- 3) Press OK to confirm.
- Press the Menu icon to return to main menu.





## 5.5 - SCREEN SAVER

Allows you to set the screen saver starting point.

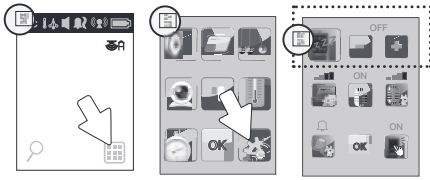

- Press the **Me** icon to access main menu.
- Press the **Screen Saver** icon to access sub menu.
- Press the **Screen Saver** icon to select the delay before video mode turn into screen saver mode.
- Press OK to confirm.

### NOTE:

Green Saver icon will appear when video is in Green Saver mode.



### MANUAL SETTING:

To manually trigger the screen saver mode quickly press the Parent Unit Power button. Do not press the power button for more than 2 seconds since this will shut down the Parent Unit.

### TO REVERT BACK TO CAMERA CAPTION

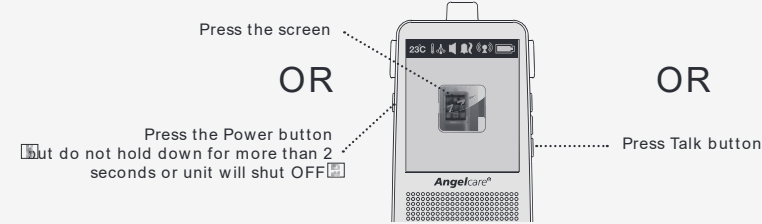

## 5.6 - INFRARED NIGHT VISION

Allows you to capture image when lighting is insufficient.

### TO ACTIVATE NIGHT VISION:

Press the **Night Vision** icon to chose available modes



- AUTO:** The infrared will turn on automatically when the lighting is not sufficient. The image transition takes 2 seconds
- ON:** The infrared are ON at all times.
- OFF:** The infrared are OFF at all times.

The icon will appear when the infrared are ON.

There are built infrared on the Nursery Unit to enable clear black and white image. The image transition takes 2 seconds.

### 5.7 - NIGHT LIGHT

Allows you to use your monitor as a night light.

TO ACTIVATE THE LIGHT:

Push right 'wing' of Nursery Unit to the night light ON or OFF.

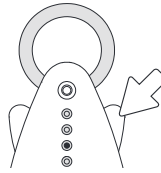

### 5.8 - ZOOM MODE

Allows you to zoom in to twice the normal view.

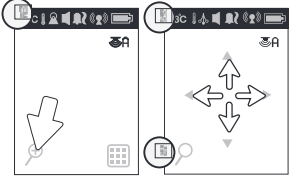

- Press the Z icon.
- Press the Dir to zoom in on what you want to see more closely.
- Press the Z icon again to return to normal view.

### 5.9 - MUTE

Allows you to put your Parent Unit in mode

TO ON :

Press the button and hold for 2 seconds to mute sound.

TO :

Press the button again and hold for 2 seconds to unmute sound.

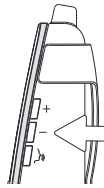

NOTE:

On the Parent Unit, the will blin

## 5.10 - KEY TONE

Allows you to activate or deactivate key tone sound.

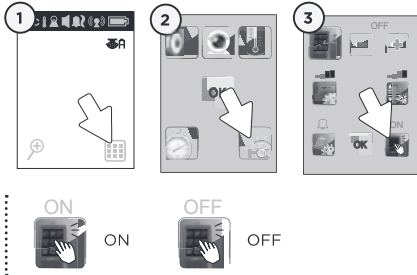

- 1) Press the **Menu** icon to access main menu.
- 2) Press the **Settings** icon to access sub-menu.
- 3) Press icon to **activate** or **deactivate** key tone sound.
- 4) Press **OK** icon to confirm.

## 5.11 - TIMER

Allows you to time certain activities.

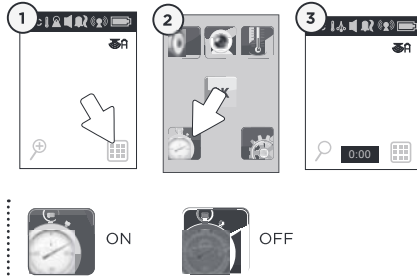

- 1) Press **Menu** icon to access main menu.
- 2) Press **Timer** icon to start or stop the timer.
- 3) View **Timer** in video mode. (shows in minutes only).
  - Stops automatically after 5 hrs 59 min.
  - Stops automatically if the Parent Unit is turned **OFF**.

## TAKING CARE OF YOUR RECHARGEABLE BATTERIES

- Ensure that you fully charge your batteries for 10 hours before their first use.
- To maintain maximum battery life it is recommended that you fully discharge your batteries periodically. Battery performance can be diminished by leaving the batteries constantly charging on the charging cradle. If your Parent Unit is not in use please turn it OFF.
- Inadequate battery power can impair the performance of your monitor. If you are not happy with the performance of your Parent Unit monitor please replace the rechargeable batteries with new rechargeable batteries.
- It is advisable to change the batteries every 6 months.

## NO SOUND IS BEING TRANSMITTED

- Check that both units are powered on.
- Check that both units are plugged into functioning electrical outlets.
- Check the batteries in both units replace or recharge them if necessary.
- Check on the top bar of the Parent Unit to see if the monitor is on "MUTE" instead of "ON". Refer to Step 5.9

## NURSERY UNIT POWER ON INDICATOR (GREEN LIGHT) DOES NOT LIGHT UP

- Check connections or change to another electrical outlet.
- Push and hold the left 'Ring' for 3 seconds to turn the Nursery Unit ON.

## WEAK RECEPTION

- Bring units closer together.
- Change the position of one or both units.
- Place units on a flat surface away from baby's reach.
- Replace the batteries or recharge Parent Unit.

STATIC, DISTORTION, INTERFERENCES  
(FROM OTHER MONITORS, WIRELESS PHONES, WALKIE-TALKIES, ETC)

- Rotate Parent Unit or move it away from source of interference.

## FEEDBACK (LOUD NOISES EMITTED FROM THE PARENT UNIT)

- Move units farther apart at least 3 meters.
- Decrease volume on Parent Unit.

## THE PARENT UNIT SCREEN IS BLACK (PARENT UNIT IS OFF)

- Turn the Parent Unit back ON by pushing and holding the power button for 3 seconds.
- Replace the batteries or recharge Parent Unit.

## LIMITED WARRANTY

Angelcare® warrants to the original owner of this product that Angelcare® video and sound monitor (model AC1120) is free from any material and workmanship defects, for a period of one (1) year from the date of the original purchase. If this monitoring system fails to function properly when used as directed under normal conditions within the one year period, Angelcare® will either repair or replace the product, at our discretion, free of charge. Please contact your distributor.

The product must be accompanied by a proof of purchase, either a bill of sale or other proof that the monitoring system is within the warranty period. Angelcare® will bear the cost of repairing or replacing the product and shipping it back to you.

**This warranty does not apply to a product which has been damaged as a result of improper maintenance, an accident, improper voltage supply or any other form of misuse. The warranty is also void if the owner repairs or modifies the product in any way. Angelcare® is not liable for any incidental or consequential damages with regard to this product. The warranty also excludes any liability other than what is stated above. No other warranty is given.**

This warranty does not cover products and accessories which are not Angelcare-branded, or any problems that result from usage that is not in accordance with product instructions, failure to follow the product instructions, or problems caused by using accessories, parts or components not supplied by Angelcare.

LEGAL RIGHTS VARY FROM COUNTRY TO COUNTRY. SOME COUNTRIES DO NOT ALLOW THE EXCLUSION OR LIMITATION OF INCIDENTAL OR CONSEQUENTIAL DAMAGES, SO THE ABOVE LIMITATIONS MAY NOT APPLY TO YOU.

WE ARE NOT IN ANY WAY RESPONSIBLE FOR ANY OUTCOME RESULTING FROM THE USE OF THIS PRODUCT.

## IMPORTANT!

This Angelcare® monitor is a personal care product. Please do not return this product to the store. If you have questions or need help, please call your distributor before returning this product.

TECHNICAL SPECIFICATIONS

Range:  
Open field (Open area without obstructions): up to 200 meters.

Number of Channels:  
USA/Canada: 4 channels.  
Europe: 8 channels.

Power Supply:  
AAA alkaline batteries (not included) or  
USB-C Adapter for Charger Unit.

AAA rechargeable batteries and USB-C  
adapter for Charger Unit for the Parent  
Unit.

Caution: To reduce the risk of electric  
shock, do not expose this product to rain  
or moisture.

Batteries: Risk of explosion if batteries are  
incorrectly replaced. The included batteries  
are AAA rechargeable batteries  
manufactured by Sanyo (AAA CR123 1000mAh) or  
Duracell (AAA CR123 1000mAh) or  
Duracell (AAA CR123 1000mAh).

They may only be replaced by  
AAA NiMH rechargeable batteries.

Notes:

- Do not mix old and new batteries.
- Do not mix alkaline standard (carbon zinc) or rechargeable (NiCd, NiMH, etc) batteries.

Transmission:

Data transmission between the Parent  
Unit and Charger Unit is made on the 2.4GHz  
frequency.

Preparacion de la declaración de conformidad. Se declara  
que este monitor de bebé cumple con los requisitos  
esenciales y otras disposiciones de la Directiva 2014/53/UE.

La declaración de conformidad puede obtenerse a través  
de nuestro distribuidor local. Consulte la dirección en el manual.



PROTECT THE ENVIRONMENT

This electronic equipment contains reusable material and must not be disposed  
with domestic waste. Please take it to a collection point for electric and electronic  
equipment (ask your local authorities for details).

ErP COMPLIANCE

South America (Brazil, Chile, Colombia, Ecuador, Peru, Uruguay, Venezuela)  
Use only Anicare® brand power supply model number 10000000

Europe  
Use only Anicare® brand power supply model number 10000002

Australia  
Use only Anicare® brand power supply model number 10000002

Canada  
Use only Anicare® brand power supply model number 10000002



## Also available at Megababy...

### Angelcare Soft-Touch Bath Support

The Soft-Touch Bath Support provides optimal comfort and safety for your baby as it is placed directly in the bath. Its unique design combines safe, sturdy sides and an angled area made from special soft material for your baby.

The soft TPE material does not only mould comfortably around your baby, but also takes up the bath water's temperature very quickly, which makes your baby feel warm and safe. Suitable from birth.

**PLEASE NEVER LEAVE YOUR CHILD UNATTENDED WHILE BATHING.**

RSP £24.99

soft material absorbs water temperature



#### DURABLE & LIGHTWEIGHT

Bath Support has a layer of soft TPE material, which warms very quickly to baby's body temperature and bath water.



#### HYGIENIC & MOULD-RESISTANT

The mesh material allows water to drain easily from the bath support and dry quickly.



#### USED DIRECTLY IN THE BATH

The perfect height for easy and comfortable bathing. The water level indicator on the bath support and the non-slip rubber base provides optimal safety.



#### EASY TO STORE

This baby bath support has two carry handles and a handy loop at top so that you can hang it up for convenient storage.



#### ERGONOMIC DESIGN

Ergonomically designed bath support, providing optimal support, comfort and safety for baby.



scan me!  
Watch the video

for more information visit [www.angelcare.co.uk](http://www.angelcare.co.uk)



## Also available at Megababy...

### Nappy Disposal System

The Angelcare Nappy Disposal System is a convenient and hygienic way of disposing of dirty nappies. Featuring Air-Seal technology designed to keep bad smells at bay, this simple-to-use system makes for a happier, more fragrant home. It also makes a fantastic family bathroom bin when the nappy days are over.

including free first cassette!



#### HYGIENIC PUSH & LOCK

Simply push nappy in to lock smells in



#### AIR SEAL

The advanced multi-layer film provides an effective odour barrier



#### 100% COMPATIBILITY

All Angelcare cassettes are suitable for all Angelcare Nappy Disposal Systems



#### EASY-TO-USE REFILL

Each (refill) cassette includes enough bags to last 1 month



#### ENVIRONMENTALLY FRIENDLIER

Uses up to 4 times less plastic than other systems



#### ONE-HANDED OPERATION

No difficult twisting required to use



#### SAFE AND SIMPLE

The cutting mechanism is inside the nappy bin



#### EASY TO EMPTY

Remove it just like a normal bin liner (approximately once a week)



For latest prices on all Angelcare products visit:  
**megababy.co.uk**

### Refill Cassettes

The Angelcare refill cassettes help to provide a convenient and hygienic way of disposing of dirty nappies. A pack of 3 refill cassettes is normally enough for up to 3 months of usage.

Buy Refill Cassettes online at  
**www.megababy.co.uk**



for more information visit [www.angelcare.co.uk](http://www.angelcare.co.uk)





This Angelcare Baby Monitor is a Personal Care Product. Please DO NOT return this to the store. Contact initially for advice and assistance.

Angelcare Helpline on 0345 009 1789

Website: [www.angelcare.co.uk](http://www.angelcare.co.uk)

Chat Helpline: [babyhelpline.co.uk](http://babyhelpline.co.uk)

Next business day is on Monday to Friday, 9am to 4pm, excluding bank holidays.

Mega is the only authorised dealer for Angelcare Spare Parts in the UK.



IM120-INT-04 09/15