

# Angelcare®

FOR YOUR PEACE OF MIND

## OWNER'S MANUAL

MOVEMENT & SOUND BABY MONITOR

Model AC403



**DON'T FORGET**

## IMPORTANT ADVICE FOR INITIAL SETUP



### **Movement Alarm**

Your monitor comes with the movement alarm activated. When switching on your monitor it will alarm, with or without the Sensor Pad plugged in, if no movement is detected. Deactivate the movement function to use the monitor without the Sensor Pad.



### **Batteries**

Insert the enclosed rechargeable batteries into the Parent Unit. If inserted incorrectly the Parent Unit will not charge when placed in the charging cradle. The battery icon will flash briefly on the Parent Unit screen to indicate charging.



### **Cord Safety**

Ensure the Nursery Unit is at least 1 metre away from your baby's cot. The Sensor Pad cord must always be kept out of reach of baby and secured using the cord cover kit provided.



### **Voice-activated Sound Transmission**

Your monitor will transmit when it detects sound from your baby or in their room. You can adjust the microphone sensitivity to suit your needs.

**PLEASE FOLLOW THE INSTRUCTIONS CAREFULLY FOR CORRECT SETUP**

Please **DO NOT** return this product to the store. For assistance please contact our helpline on **0845 009 1789** or email [helpline@babyhelpline.co.uk](mailto:helpline@babyhelpline.co.uk)  
Mon - Fri 10am - 4pm, excluding bank holidays.

## TABLE OF CONTENT

 WARNINGS .....	3
AC403 SETUP REQUIREMENTS .....	7
STEP 1 - Charging the Parent Unit (15 hours) .....	8
STEP 2 - Installing the Sensor Pad .....	10
STEP 3 - Setting up the Nursery Unit .....	13
STEP 4 - Turning on your Monitor .....	14
STEP 5 - Testing and Getting to know your monitor .....	16
STEP 6 - Activating and deactivating additional functions .....	20
Troubleshooting .....	25
Limited warranty .....	27
Technical specifications .....	28

## OWNER'S MANUAL

KEEP YOUR OWNER'S MANUAL FOR FUTURE REFERENCE.

PLEASE READ THE WARNINGS AND INSTRUCTIONS CAREFULLY BEFORE ASSEMBLING & USING THE PRODUCT.

FAILURE TO FOLLOW THE WARNINGS AND THE INSTRUCTIONS COULD RESULT IN SERIOUS INJURY OR DEATH OR DAMAGES TO THE PRODUCT.

THE SENSOR PAD FEATURE IS NOT FOR USE WITH ADULTS, CHILDREN OR INFANTS OLDER THAN 24 MONTHS.

THE SENSOR PAD IS NOT INTENDED TO BE USED TO DETERMINE IF A CHILD IS OUT OF THE CRIB.

## WARNING

Adult assembly required.

Keep small parts away from children when assembling.



This Angelcare Monitor is a Personal Care Product. Please DO NOT return this to the store where you purchased it from. If you have any questions or require assistance please call the Angelcare Helpline on 0845 009 1789 or email [helpline@babyhelpline.co.uk](mailto:helpline@babyhelpline.co.uk).

The Baby Helpline is open Monday to Friday, 10am to 4pm. The helpline is closed on bank holidays.

For additional FAQs and to download instruction manuals visit; [www.angelcare.co.uk](http://www.angelcare.co.uk).

To order spare parts for your Angelcare Baby Monitor visit; [www.megababy.co.uk](http://www.megababy.co.uk).

## WARNING

1. THIS PRODUCT CANNOT REPLACE RESPONSIBLE ADULT SUPERVISION. This product is designed to aid in the monitoring of your child. When using the monitor, you must still provide the supervision necessary for the continued safety of your child. Monitoring of premature babies, or those considered to be at risk, should always be carried out under the supervision of a health professional. This monitor SHOULD NOT be used as a medical device, nor as a device to prevent Sudden Infant Death Syndrome (SIDS).

2. WARNING Strangulation Hazard – Children have STRANGLED in cords. Keep adapter cords out of the reach of children (more than 1m away). NEVER use Sensor Pad(s) without the protective cord covering. Check protective cord covering before each use. Immediately discontinue use of Sensor Pad(s) if protective covering is damaged or broken.



3. Never use extension cords with AC adapters. ONLY use the AC adapters provided.

4. When an AC Adapter is plugged into an electrical outlet, DO NOT touch the exposed end.

5. ALWAYS be sure that both the transmitter and receiver are working properly and are within range of each other. Test monitor before first use, periodically and when changing location of the Nursery Unit.

6. ALWAYS be sure to immediately check on baby whenever an alarm sounds.

7. DO NOT use monitor near water (such as bath tub, sink, etc.).



8. Keep monitor AWAY from heat sources (such as stoves, radiators, etc.).

9. ALWAYS place both the Nursery Unit and Parent Unit on a flat surface in an upright position and allow for proper ventilation. DO NOT place on sofas, cushions, beds, etc. which may block ventilation.

10. This monitor uses public airwaves to transmit signals. The Parent Unit may pick up signals or interference from other nursery monitors in your area. Your monitor may even be picked up by other households. To protect your privacy, make sure both units are turned OFF when not in use. If you experience interference, change the channel on both units.

11. This product is NOT a toy. DO NOT allow children to play with it.

12. This product contains small parts. Adult assembly required. Exercise care when unpacking and assembling the product and keep small parts away from children.

13. Use and store the monitor at a temperature between 10 °C and 40 °C.

## BATTERY WARNING

14. Use ONLY AAA RECHARGEABLE batteries for the Parent Unit. DO NOT mix old and new batteries. DO NOT mix alkaline, standard or rechargeable batteries. Insert batteries with correct polarity. DO NOT short-circuit supply terminals. ONLY use the recommended batteries or equivalent (volts and size) and the correct adapter. Remove batteries when product is stored for long periods of time or when batteries are exhausted. Dispose exhausted batteries properly. DO NOT recharge non-rechargeable batteries. Rechargeable batteries are ONLY to be charged under adult supervision. Keep all batteries away from children.

## 15. IMPORTANT SAFETY INSTRUCTIONS

**15.1** Read these instructions - All the safety instructions should be read before the product is operated.

**15.2** Keep these instructions. The safety and operating instructions should be retained for future reference.

**15.3** Heed all warnings - All warnings on the product and in the operating instructions should be adhered to.

**15.4** Follow all instructions - All operating and use instructions should be followed.

**15.5** Water and moisture - DO NOT use this apparatus near water. For example, near a bath tub, wash bowl, kitchen sink, laundry tub, in a wet environment or near a swimming pool and the like. Care should be taken so that objects DO NOT fall onto units and that liquids are not spilled into either unit or Sensor Pad through its openings.

**15.6** Cleaning - Disconnect all units before cleaning. DO NOT immerse in water any part of the Nursery Unit, Parent Unit. Clean only with dry cloth. DO NOT spray with cleaning products or solvents. Wipe Sensor Pad with a cloth moistened very slightly with an antiseptic or mild detergent.

**15.7** Ventilation - DO NOT block any ventilation openings. Allow for proper ventilation when units are in use. DO NOT cover the Nursery Unit or Parent Unit with any object such as a blanket. DO NOT place it in a drawer or in any location which would muffle the sound or interfere with the normal flow of air.

**15.8** Heat sources - DO NOT install near any heat sources such as radiators, heat registers, stoves, TVs or other apparatus (including amplifiers) that produce heat. Heat can damage the case or electrical parts.

**15.9** Power cord protection - Protect the Sensor Pad cord and Adapter's power cord from being walked on or pinched by furniture or other items - Power supply cords should be routed so that they are not likely to be walked on or pinched by items upon or against them, paying particular attention to cords and plugs, convenience receptacle, and the point where they exit from the product.

**15.10** Accessories - Only use attachments/accessories specified by the manufacturer. DO NOT place this product on an unstable cart, stand, tripod, bracket or table. The product may fall, causing serious injury to a child or adult and serious damage to the product. Use ONLY with a cart, stand, tripod, bracket or table recommended by the manufacturer or sold with the product. Any mounting of the product should follow the manufacturer's instructions.

**15.11** Unplug this appliance during lightning storms or when not used for long periods of time.

**15.12** Servicing - DO NOT attempt to service this product yourself as opening or removing covers (except battery doors) may expose you to dangerous voltage or other hazards.

**15.13** Replacement parts - When replacement parts are required, be sure the replacement parts specified by the manufacturer have the same characteristic as the original part. Unauthorized substitution may result in fire, electric shock or other hazards.

**15.14** Usage - This baby monitor is intended as an aid. It is NOT a substitute for responsible and proper adult supervision and should not be used as such. Use this appliance ONLY for its intended use as described in this manual.

**15.15** Power Sources - Operate this product only from the type of power source indicated on the type plate of the adaptor. If you are unsure of the type of power supply to your home, consult your dealer or local power company.

**15.16** Overloading - DO NOT overload wall outlets, extension cords or integral convenience receptacles as this can result in a risk of fire or electric shock.

**15.17** Object and Liquid Entry - NEVER push objects of any kind into this product through casing slots as they may touch dangerous voltage points or short out parts that could result in a risk of fire or electric shock. NEVER spill liquid of any kind on the product.

**15.18** Antenna - The antenna used for this transmitter must be installed to provide a separation distance of at least 20 cm from all persons and must not be collocated or operating in conjunction with any other antenna or transmitter.

**15.19** Power Lines - An outside antenna system should NOT be located in the vicinity of overhead power lines or other electric light or power circuit, or where it can fall into such power lines or circuits as contact with them may be fatal.

**15.20** WARNING Strangulation Hazard — Children have STRANGLED in cords. Keep adapter cords out of the reach of children (more than 1m away). NEVER use Sensor Pad(s) without the protective cord covering. Check protective cord covering before each use. Immediately discontinue use of Sensor Pad(s) if protective covering is damaged or broken.



**15.21** Interference - This monitor uses public airwaves to transmit signals. The Parent Unit may pick up signals or interference from other nursery monitors in your area. Your monitor may even be picked up by other households. To protect your privacy, make sure both units are turned OFF when not in use. If you experience interference, change the channel on both units.

**15.22** Vibration Source - When the monitor is in use, DO NOT use a crib mobile or other crib accessories that may produce vibrations. Other sources of vibrations may include fans, washing machines, loud music, etc. These sources of vibration may interfere with the performance of your Angelcare® monitor and the alarm will not sound if it continues to detect any movement other than your baby's. Be sure all vibration sources are eliminated before using the monitor.

You may experience false alarms for several reasons. The most common reason is the Nursery Unit has not been turned OFF after you have removed your baby from the crib. Another reason is the Sensor Pad has not been placed under the mattress properly.

Be sure the Sensor Pad is on a flat, firm surface with the printed side facing up. The sensitivity level may also need to be adjusted. Refer to step 5.3. Always be sure to immediately check on baby whenever an alarm sounds.

**15.23** Sensor Pad - If the crib has a spring or slat base, place a hard board between the crib base and the Sensor Pad measuring at least 33 x 33 cm and 6 mm thick. Only use your Angelcare® monitor in a stationary sleeping environment such as a crib where

the Sensor Pad can rest on a completely flat, firm surface.

## 16. IMPORTANT SAFETY INSTRUCTIONS RELATED TO USE OF BATTERIES

**16.1** Use ONLY the type and size of batteries specified in the owner's manual. There is a risk of explosion if batteries are replaced with an incorrect type.

**16.2** Use ONLY AAA rechargeable batteries and/or the AC Adapters provided for the Parent Unit. You must use only rechargeable batteries in the Parent Unit. DO NOT use alkaline batteries or you will severely damage the unit.

**16.3** Charge the batteries for 15 hours prior to first use. Be sure to have the monitor in the OFF position during this period. ONLY use the AC Adapters included with your monitor.

**16.4** DO NOT use these adapters with any other equipments.

**16.5** When unplugging the AC Adapter from the Nursery Unit, be sure it is switched to the OFF position. If it isn't, the unit will revert to battery mode if batteries are installed.

**16.6** DO NOT use rechargeable batteries in the Nursery Unit. Use alkaline batteries ONLY.

**16.7** DO NOT dispose batteries in fire. They may explode. Check with local regulations for possible special disposal instructions.

**16.8** Exercise care in handling batteries in order not to short out the batteries with conducting materials such as rings, bracelets and keys. Overcharging, short circuiting, reverse charging, mutilation, or incineration of batteries must be avoided to prevent one or more of the following occurrences: release of toxic materials, release of hydrogen and/or oxygen gas, rise in surface temperature.

**16.9** DO NOT attempt to recharge batteries provided with or identified for use with this product that are not intended to be charged. The batteries may leak corrosive electrolyte or explode.

**16.10** DO NOT attempt to rejuvenate the batteries provided with or identified for use with this product by heating them. Sudden release of battery electrolyte may occur, causing burns or irritation to eyes or skin.

**16.11** If and when necessary, the batteries must be replaced with identical new ones or equivalent (volts and size). If a battery to be replaced is connected with other batteries in series, replace the other batteries at the same time as well. DO NOT mix old and new batteries.

**16.12** Reverse polarity installation of the batteries in the end product must be avoided. Reverse insertion of batteries can cause charging, and that may result in leakage or explosion.

**16.13** Remove batteries from this product if you store the product over 30 days because the batteries could leak and damage the product.

**16.14** Discard 'dead' batteries as soon as possible since 'dead' batteries are more likely to leak in a product. If a battery has leaked or vented, it should be replaced immediately using protective gloves.

**16.15** DO NOT store this product, or the batteries provided with or identified for use with this product, in high-temperature areas.

## **FC WARNING** (North America Only)

**17.1** Modifications not authorized by the manufacturer may void users authority to operate this device.

**17.2 NOTE:** This equipment has been tested and found to comply with the limits for a Class B digital device, pursuant to Part 15 of the FCC Rules. These limits are designed to provide reasonable protection against harmful interference in a residential installation. This equipment generates, uses and can radiate radio frequency energy and, if not installed and used in accordance

with the instructions, may cause harmful interference to radio communications.

**17.3** However, there is no guarantee that interference will not occur in a particular installation. If this equipment does cause harmful interference to radio or television reception, which can be determined by turning the equipment OFF and ON, the user is encouraged to try to correct the interference by one or more of the following measures:

- Reorient or relocate the receiving antenna.
- Increase the separation between the equipment and receiver.
- Connect the equipment into an outlet on a circuit different from that to which the receiver is connected.
- Consult the dealer or an experienced radio/TV technician for help.

**17.4** This device complies with part 15 of the FCC Rules. Operation is subject to the following two conditions:

- (1) This device may not cause harmful interference, and
- (2) This device must accept any interference received, including interference that may cause undesired operation.

## **FCC AND IC REGULATIONS**

### **RF radiation exposure statement**

The Nursery Unit complies with FCC RF radiation exposure limits set forth for an uncontrolled environment. Caution: To maintain the compliance with the FCC's RF exposure guideline, install the Nursery Unit at least 20 cm from from ALL persons. The transmitter of this device must not be co-located or operating in conjunction with any other antenna or transmitter.

### **Industry Canada**

This product meets the applicable Industry Canada technical specifications. CAN ICES-3 (B)/NMB-3(B)

# SETUP REQUIREMENTS

## INCLUDED:



1 Parent Unit (AC403) or  
2 Parent Units (AC403-2PU  
and AC403-2PU-2SP)



Nursery Unit

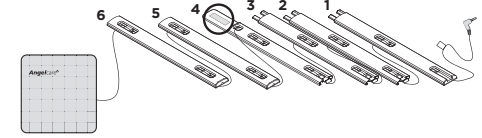

1 Sensor Pad (AC403) or 2 Sensor Pads  
(AC403-2PU-2SP) with pre-installed cord covers

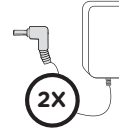

2 AC Adapters (AC403) or  
3 AC Adapters (AC403-2PU  
and AC403-2PU-2SP)

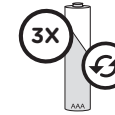

3 Rechargeable AAA Batteries (AC403) or  
6 Rechargeable AAA Batteries (AC403-2PU  
and AC403-2PU-2SP)

## YOU MUST PREPARE:

One hardboard (not included)  
Thickness: **6 mm**  
Minimum dimensions:  
**33 cm x 33 cm**  
Maximum dimensions:  
equal to the mattress size



Hardboard

## IMPORTANT

The hardboard must be larger than the Sensor Pad surface area or in the case of the AC403-2PU-2SP of two Sensor Pads.

## WHAT YOU WILL NEED (NOT INCLUDED):



4 AAA Alkaline  
Batteries  
for Nursery Unit



Miniature Philips  
Screwdriver

## BABY'S ROOM:

## IMPORTANT

Place the crib near a supporting wall and far from air currents. Install the Nursery Unit on a flat, stable surface facing the crib at a distance of at least 1 meter.

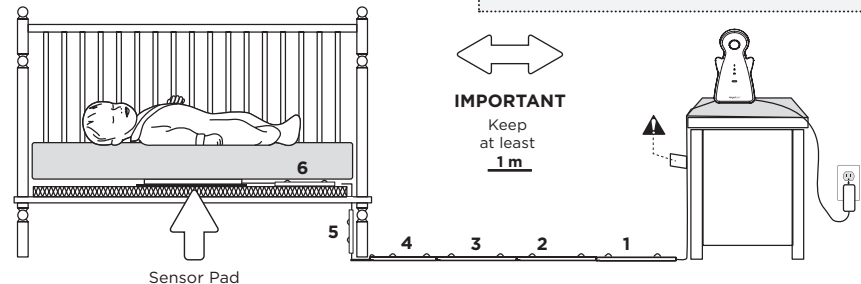

Sensor Pad

## STEP 1 - CHARGING THE PARENT UNIT (15 HOURS)

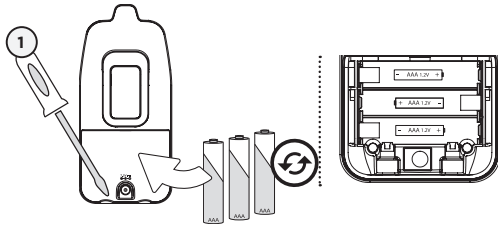

**IMPORTANT**  
Never use regular alkaline batteries in the Parent Unit; they may explode.

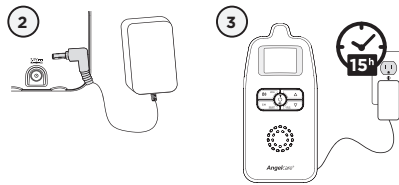

- 1) Remove the battery cover and insert the Rechargeable Batteries (included).
- 2) Connect the AC Adapter to the Parent Unit and into an electrical outlet.
- 3) Charge the unit for **15 continuous hours** (prior to first use).

**NOTE:**

To optimize your battery performance please refer to Battery Guidelines in the Trouble Shooting section.

### 1.1 - BATTERIES

**HOW TO CHECK THE BATTERIES:**

Unplug the AC Adapters from both units.

- If the Nursery Unit **Power Indicator** does not show or if the Low Battery Indicator does show, replace the batteries.
- If the Parent Unit screen does not light up or it switches off, recharge the batteries.

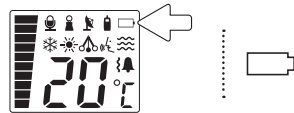
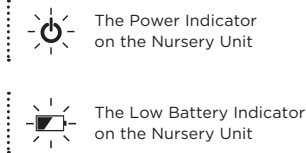

**PARENT UNIT BATTERY ALARM**

- Alarm activates when batteries need to be recharged.
- Parent Unit will emit a beep sound every 15 seconds.
- Battery Alarm icon will show on screen.

**HOW TO CHARGE THE BATTERIES IN THE PARENT UNIT:**

Plug the AC into the Parent Unit and a working electrical outlet. Your Parent Unit can function with the batteries at 1/2 capacity but it is recommended that they are fully charged before unplugging from the AC Adaptor and power outlet for maximum use.

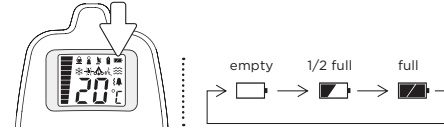
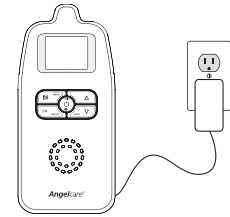

**PARENT UNIT:**

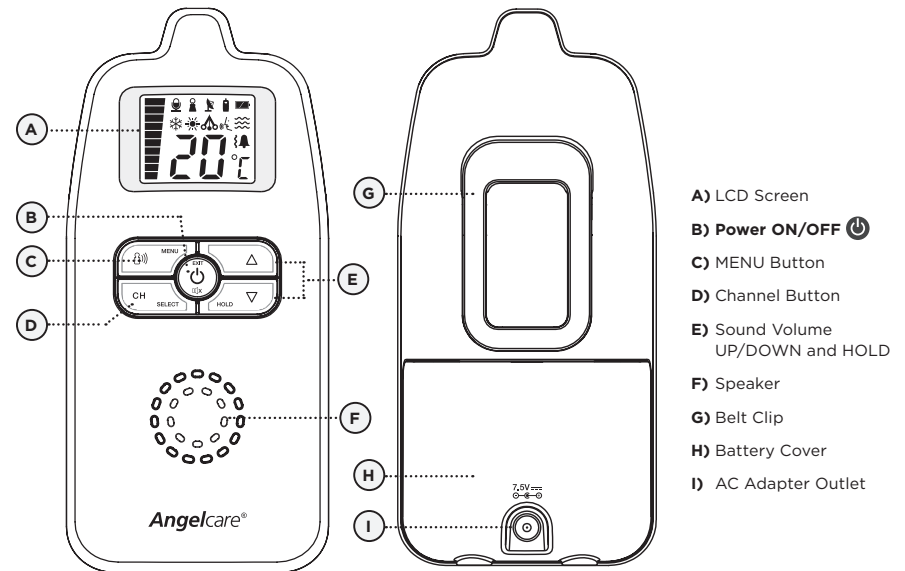

Front View

Rear View

- A) LCD Screen
- B) Power ON/OFF
- C) MENU Button
- D) Channel Button
- E) Sound Volume UP/DOWN and HOLD
- F) Speaker
- G) Belt Clip
- H) Battery Cover
- I) AC Adapter Outlet

## STEP 2 - INSTALLING THE SENSOR PAD

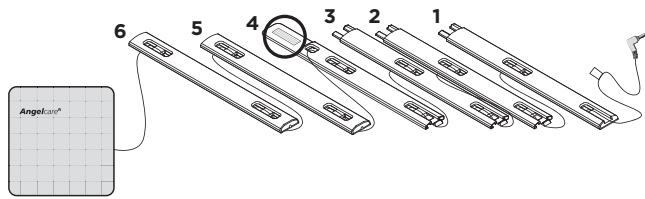

Sensor Pad with pre-installed cord covers

**Cord covers 1, 2, 3, 4:**  
Position on floor

**Cord cover 4:**  
Contains double sided tape to securely install beneath crib leg

**Cord cover 5:**  
Position vertically between mattress support and floor

**Cord cover 6:**  
Place under the mattress

### ⚠ WARNING STRANGULATION HAZARD.

Children have been STRANGLERED by cords.

- Keep adapter cords out of the reach of children (more than 1 m away).
- Because of the serious strangulation risk to infants and toddlers, parents and caregivers should never place the Nursery Unit within 1 m of a crib.
- **NEVER** use Sensor Pad without the cord covers. Check cord covers before each use to ensure it is securely placed under the leg of the crib. Discontinue use of Sensor Pad if any cord covers are damaged or broken.
- **NEVER** use extension cords with AC adapters. **ONLY** use the AC adapters provided. This product is not a toy. Never allow children to play with it.

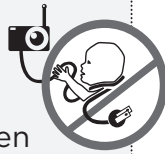

### 2.1 - SELECT A LOCATION FOR THE NURSERY UNIT

Select a location for the Nursery Unit that is at least **1 m away from the crib**.

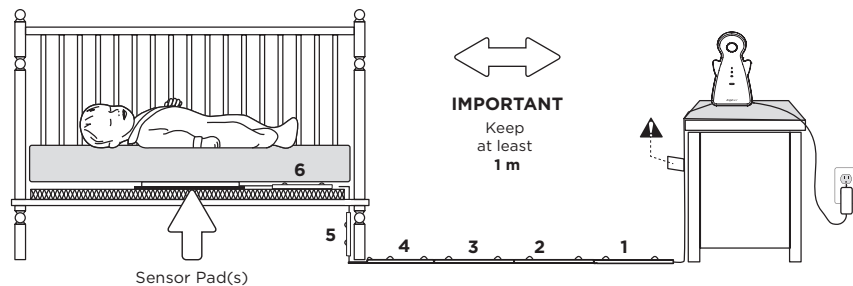

Sensor Pad(s)

### 2.2 SELECT THE CRIB LEG YOU WILL BE USING TO SECURE THE CORD COVERS

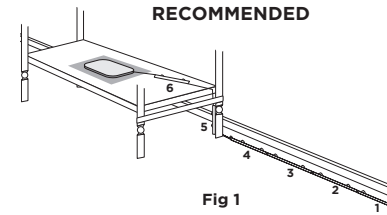

Fig 1

OR

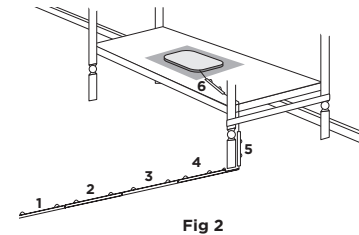
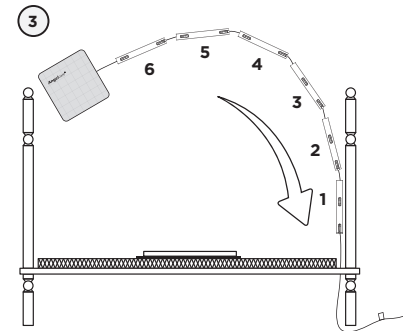

Fig 2

- 1) Use the crib leg by the wall closest to the Nursery Unit (**Fig 1**). In cases where the Nursery Unit is across the room, use the leg closest to the Nursery Unit to position the covered wire (**Fig 2**). It is always preferable that the covered cord run along a wall.

### 2.3 - INSTALL THE SENSOR PAD ON THE MATTRESS SUPPORT



- 1) Remove the mattress from the crib.
- 2) Place the Sensor Pad - printed side up - on top of the **hardboard** at the center of the crib.
- 3) Run the connection pin, warning label and the first 5 cord covers down along the backside of the crib leg, **between the mattress support and the inside edge of the crib**.
- 4) Bring the first 4 cord covers down the floor, and keep the 5<sup>th</sup> cord cover vertically, along the backside of the crib leg, **(between the mattress and the inside edge of the crib)**.
- 5) Remove any cord slack to make sure no parts of the cord are loose.

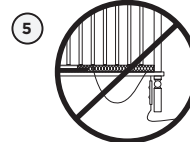
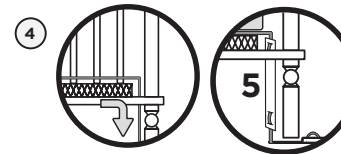

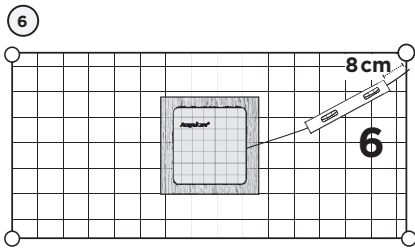

6) Place the 6<sup>th</sup> cord cover approximately 8 cm from the edge of the mattress support.

7) Snap together the remaining cord covers that will run along the floor.

8) Remove any cord slack to make sure no parts of the cord are loose.

9) Peel off the double-sided tape on the 4<sup>th</sup> cord cover and place it securely under the crib leg.

10) Install the Nursery Unit on a flat, stable surface facing the crib at a distance of at least 1 m and plug the Sensor Pad cord into the Nursery Unit.

11) Check to make sure the Sensor Pad has not moved from position.

12) Place the mattress back inside the crib.

The Sensor Pad functions with any size and type of mattress except memory-foam mattresses and hollow frame mattresses.

The hardboard maintains a constant pressure on the Sensor Pad, enabling it to detect the baby's movements even when the baby is at the edges of the crib.

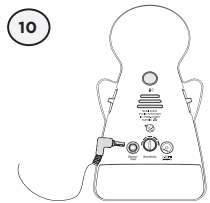
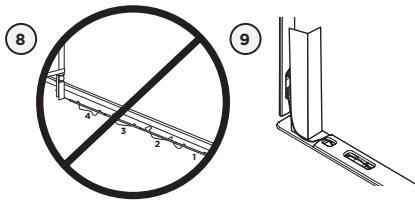
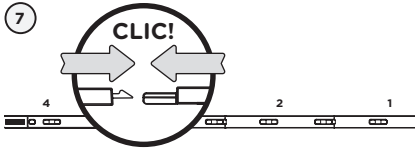

## WARNING STRANGULATION HAZARD

- Remove all slack from Sensor Pad Cord.
- When lowering the mattress support as your child grows, slide the vertical Cord Cover (5) upward so it remains approximately in the center between the mattress support and the floor. Slide the Sensor Pad Cord through the Floor Cover to eliminate any additional slack.

- The Sensor Pad is not designed for use with adults, children or infants older than 24 months.
- Discontinue use of the Sensor Pad when child is older than 24 months. Remove sensor pad from crib and store for future use.
- BEFORE FIRST TIME USE: To test that the unit is ready for use, refer to instruction manual on how to test that the installation has been done

## STEP 3 - SETTING UP THE NURSERY UNIT

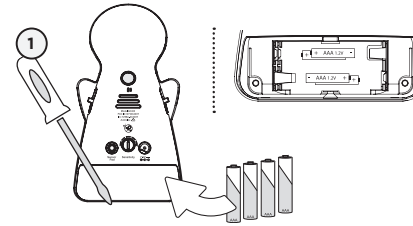

1) Remove the battery cover and insert 4 AAA Alkaline Batteries (not included).

2) Place the Nursery Unit at a **minimum of 1 m** away from the crib.

3) Connect the AC Adapter to the Nursery Unit and plug into an electrical outlet.

### NOTE:

The batteries maintain power supply in case of power outage.

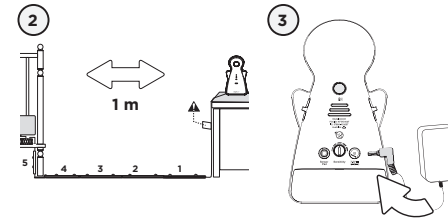

### NURSERY UNIT:

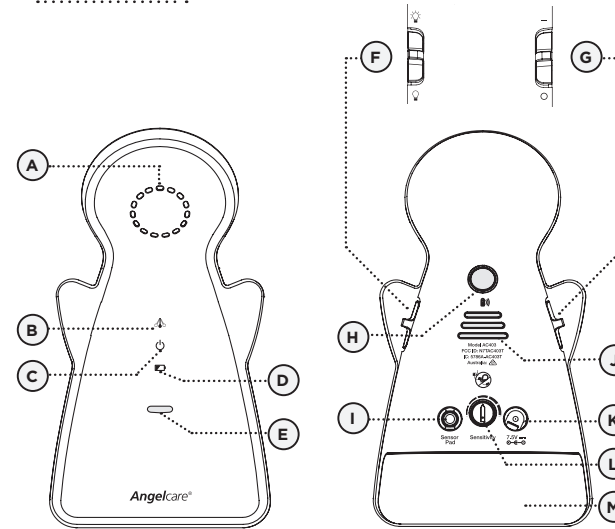

Front View

Rear View

- A) Microphone
- B) Movement 'TIC' Indicator (flashing)
- C) Power ON Indicator
- D) Low Battery Indicator
- E) Speaker
- F) Night Light Switch ON/OFF
- G) Power ON/OFF
- H) Pager Button
- I) Sensor Pad Outlet
- J) Slots for ventilation
- K) AC Adapter Outlet
- L) Sensor Pad Sensitivity Dial
- M) Battery Cover

## STEP 4 - TURNING ON YOUR MONITOR

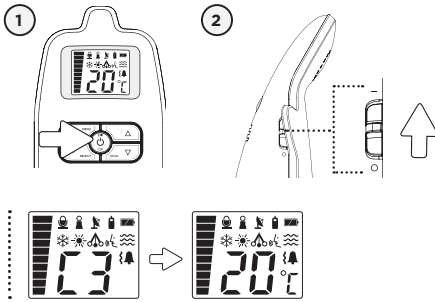

When the Parent Unit is turned ON and the Nursery Unit is OFF:

- No channel icon will appear on the screen but the Nursery Unit icon will blink.
- After 1 minute the Parent Unit will start to beep. The Parent Unit will continue to beep for 5 seconds and then shut itself off.



- 1) Press the Parent Unit **ON/OFF** button for 2 seconds.
- 2) Slide ON the Nursery Unit Power **ON/OFF** button.

### NOTE:

The screen of the Parent Unit will show the channel of transmission (C1 to C8) and after 5 seconds the room temperature and function icons.

The connecting process should be done within 30 seconds. If this sequence is not completed within 30 seconds you will need to switch the units off and start again.



- If there is a lost connection between the 2 units (refer to troubleshooting):
  - The Out-of-range icon (if activated) will blink on the screen and the Parent Unit will beep.

## CHANNEL SELECTION

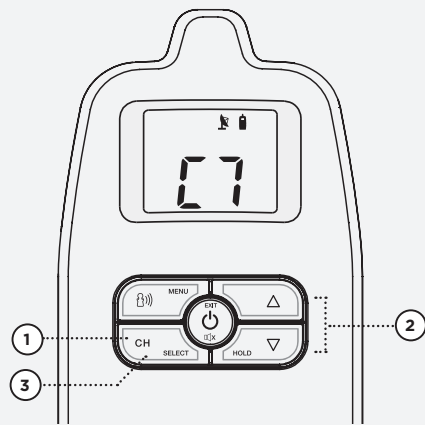

### TO SELECT THE CHANNEL:

- 1) Press and hold the select button to enter the channel mode.
- 2) Pressing either the UP or DOWN arrow will change the channel your monitor transmits on. (C1 to C8)
- 3) Press the select button again to confirm your channel selection.

### NOTE :

If the transmission is not clear, or if you hear interference sounds, you should change the channel.

## IMPORTANT ICONS



### SOUND TRANSMISSION (VOX)



#### Nursery Unit:

Appears when options are being set for the Nursery Unit



#### Out-of-Range:

Indicates the loss of connection between the Parent Unit and Nursery Unit.



#### Parent Unit:

Appears when options are being set for the Parent Unit



#### Temperature Display:

Indicates room temperature



#### Low Temperature:

Appears when low temperature alert is ON



#### High Temperature:

Appears when high temperature alert is ON



#### Channel Display:

Indicates selected channel

### Alarm mode icons:

Indicates selected alarm mode



Sound alarm



Sound alarm and vibration



Vibration only



### Volume/VOX sensitivity Level:

Indicates the volume and VOX sensitivity level.

### Detection Mode Icons:

Indicates selected detection mode:



Movement Only



Sound only



'TIC', Sound & Movement



Sound & Movement



'TIC' & Movement

### Battery Level icon:

Indicates battery level



Empty



1/2 Full



Full



Charging



## STEP 5 - TESTING AND GETTING TO KNOW YOUR MONITOR

The Angelcare® monitor can be used with the pre-program factory settings or you can also customize your settings to your preference.



All changes and adjustments made in the main menu and sub-menu will not be activated unless you confirm them by pressing the **SELECT** button followed by the **EXIT** button.

### IMPORTANT

When in MENU or SUB-MENU modes, sound transmission between Parent and Nursery Units will be temporarily deactivated.

## 5.1 - MENU ACCESS AND CHANGING THE SETTINGS

The MENU settings are accessed by using the MENU button on the Parent Unit. The MENU functions are in a loop. Each time you press the menu button briefly you move on to the next MENU function. The MENU functions are in the following order:

PRESS 1 TIME: 'TIC', Movement & Sound .....	STEP 5.2 & STEP 5.3
PRESS 2 TIMES: Out of Range .....	STEP 5.4
PRESS 3 TIMES: Sound Transmission .....	STEP 5.5
PRESS 4 TIMES: Alarm .....	STEP 5.7
PRESS 5 TIMES: Temperature .....	STEP 5.9

### NOTE:

By continuing to press the MENU button you will be continuously moving through the loop. Once you have selected your preferred settings you must press SELECT and then EXIT or your changes will not be saved.

## 5.2 - SENSOR PAD

### SENSOR PAD FUNCTIONS:



**TIC:** Allows you to detect baby's movements as well as hear a TIC sound at each movement. (This function can ONLY be activated in conjunction with the Movement Function).



**Sound Only:** Allows you to detect the baby's sounds ONLY. Movement detection will be deactivated.



**Movement Only:** Allows you to detect the baby's movements with the TIC sound.

### IMPORTANT

When in MENU or SUB-MENU mode **NO sound, alarm or vibration** will be emitted from either the Parent Unit or the Nursery Unit even if they were activated before pressing the MENU or SUB-MENU mode.

## 5.3 - CHANGING THE MOVEMENT AND SOUND MONITORING FUNCTIONS

### TO SET DETECTION MODE:

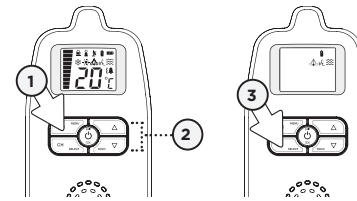

	Movement Only
	Sound Only
	'TIC', Sound & Movement
	Sound & Movement
	'TIC' & Movement

- 1) Press the **MENU** button once and the flashing icons will appear.
- 2) Use the **UP** and **DOWN** Arrows to select your preferred detection mode.
- 3) Press the **SELECT** button to confirm your choice.
- 4) Press the **MENU** to view the next option, or **EXIT** if you wish to stop programming.

If you press the **MENU** button for too long the unit will go in to connection mode and the Out-of-Range indicator will start flashing. If this happens, wait 20 seconds and then press the **MENU** to start again.

### TO TEST THE SENSOR PAD:

MOVEMENT OR 'TIC' MODE NEED TO BE ACTIVATED:

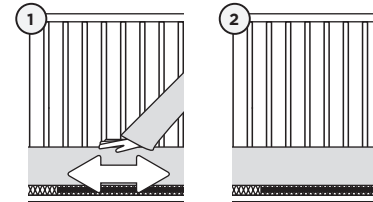

- 1) Move your hand lightly on the mattress.
  - Pendulum icon will appear on Parent Unit indicator bar. It will move as you move your hand and trigger a 'TIC' sound.
- 2) Remove your hand from the mattress. After 15 seconds you will hear a 'TIC' pre-alarm sound, and 5 seconds later the Movement Alarm will trigger.
- 3) Repeat by moving your hand lightly in all four corners of the mattress. Ensure the Nursery Unit Movement Indicator is still flashing.

### MOVEMENT ALARM

- If NO movement is detected after 15 seconds you will hear a single 'TIC' pre-alarm sound from the Nursery Unit.
- If after a further 5 seconds there is still NO movement detected both the Parent Unit and Nursery Unit speakers will emit loud warning sound.
- Nursery Unit icon flashes on the Parent Unit
- Green light on the Nursery Unit will turn off to indicate NO movement is being detected.

### IF THE ALARM DOES NOT SOUND

- Avoid contact with crib while Sensor Pad is in operation.
- Place crib near a supporting wall.
- Adjust Sensor Pad sensitivity level.

## TO STOP THE ALARM

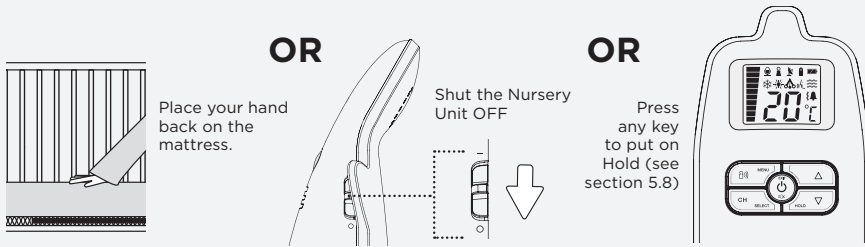

## TO ADJUST THE SENSOR PAD SENSITIVITY LEVEL:

You can adjust the Nursery Unit sensitivity dial to change your Sensor Pad from less sensitive to very sensitive. This sensitivity dial is located on the back of the Nursery Unit.

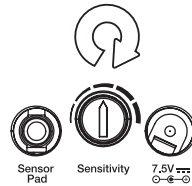

### NOTE:

If you are experiencing false alarms, adjust the sensitivity level.

For optimal results begin with the sensitivity level dial on the 3<sup>rd</sup> bar, adjusting the sensitivity by half a bar increases or decreases as required.

### IMPORTANT

- The Sensor Pad is not designed for use with adults, children or infants older than 24 months.
- Once you are finished using the Sensor Pad, please remove it from the baby's crib and store it away.

## 5.4 - OUT OF RANGE SETTINGS

Your monitor has an Out-of-Range function that advises you when your two units are not communicating. Out-of-Range situations can be caused by distance or by physical interferences.

### RANGE:

Approx up to 250 meters (open field)

## TO ACTIVATE THIS FUNCTION:

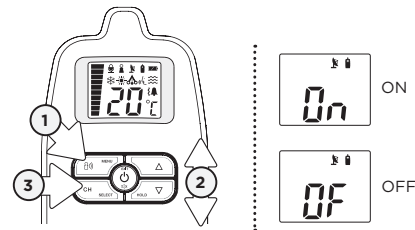

- 1) Press **MENU** button 2 times.

The Out-of-Range Indicator will blink.

- 2) Using the **UP** and **DOWN** Arrows, turn the function **ON** or **OFF**.

- 3) Press the **SELECT** button and then **EXIT** to confirm your choice.

### OUT-OF-RANGE ALARM

- Alarm activates when your two units are not communicating.
- The Parent Unit will emit a double beep every 8 seconds.
- Out of Range Icon will flash on the screen.

The Out-of range Icon will also flash when channel is being changed or the unit is reconnecting

### IMPORTANT

If the Out-of-Range function is activated and you turn the Nursery Unit OFF the Out-of-Range Alarm will sound and/or vibrate (depending on the alarm mode chosen). Turn the Nursery Unit ON again to reactivate the link.

## TO STOP THE OUT-OF-RANGE ALARM:

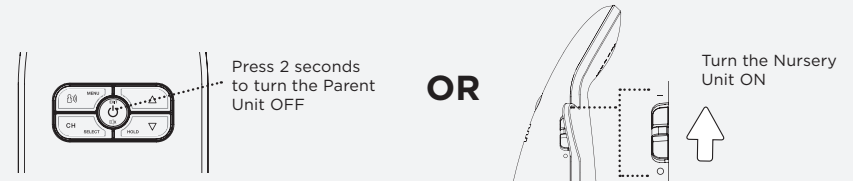

## 5.5 - SOUND TRANSMISSION (VOX)

Your monitor is 'Sound Activated'. This means that it will transmit sounds only when it detects them. It will detect even the softest levels of crying.

To save power, after 10 seconds, the sound transmission will stop if no sound is detected. Once sound is detected transmission will automatically activate.

### TO TEST SOUND:

Ask someone to speak into the Nursery Unit or place the unit near a radio to ensure that sound is being picked up.

### IMPORTANT

To avoid feedback (whistling), keep both units at least 3 meters apart.

### IF YOU HEAR NO SOUND:

- Check that both units are switched ON.
- Check that both units are plugged into functioning electrical outlets.
- Check the batteries in both units (replace or recharge them as necessary per unit).
- Bring the Parent Unit closer to the Nursery Unit.

### TO ADJUST SOUND SENSITIVITY (VOX):

The sensitivity of the microphone is adjustable and has 4 levels (the most sensitive is level 4). This means that sound will only transmit based on the level that you set.

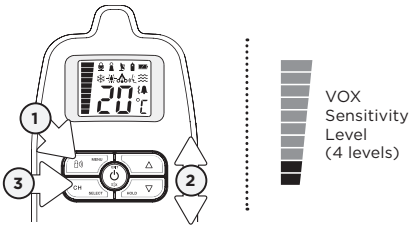

- 1) Press **MENU** button **3 times**.  
Sensitivity Level icon will appear.
- 2) With the arrow keys select desired microphone sensitivity level.
- 3) Press **SELECT** button to confirm your choice.

### ADJUST THE SOUND LEVEL

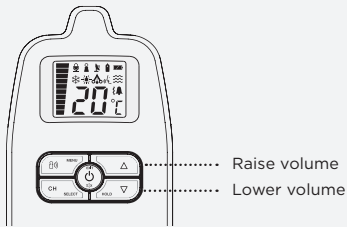

### PUT IN TEMPORARY MUTE MODE

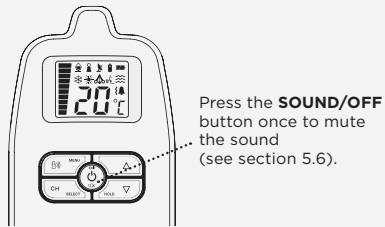

### 5.6 - TEMPORARY MUTE

Allows you to put your monitor in temporary **MUTE** mode.

**TO ACTIVATE MUTE:**  
Press the **SOUND/OFF** button.

**TO DEACTIVATE MUTE:**  
Press the **SOUND/OFF** button again to hear sounds.

After 2 minutes the sound function will be automatically reactivated.

If you press too long on the **SOUND/OFF** button it will shut down the Parent Unit.

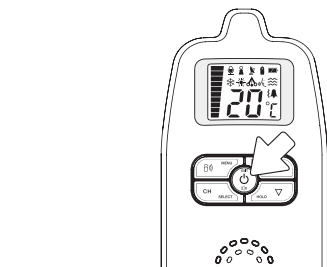

**NOTE:**  
The Sound Icon will blink on the Parent Unit whilst the Temporary MUTE is activated.

### 5.7 - ALARM SETTINGS

Allows you to select your preferred alarm mode.

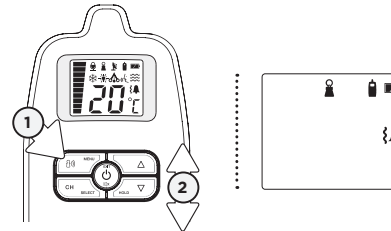

- Sound alarm
- Sound alarm and vibration
- Vibration only (the alarm will not sound on Parent Unit but it will on Nursery Unit).

- 1) Press **MENU** button 4 times.

The Nursery Unit Indicator blinks.

- 2) Using the arrows, select the desired alarm mode.

#### NOTE:

Vibration mode not available in some countries.

Sound alarm will replace vibration mode when the Parent Unit is charging.

#### IMPORTANT

Vibration option will work when the following alarm functions are activated:

- Out-of-range
- Temperature alert
- No movement detection for 20 seconds.

#### IMPORTANT

When in MENU or SUB-MENU mode **NO sound, alarm or vibration** will be emitted from either the Parent Unit or the Nursery Unit even if they were activated before pressing the MENU or SUB-MENU mode.

### 5.8 - HOLD

Allows you to put your Angelcare monitor on HOLD.

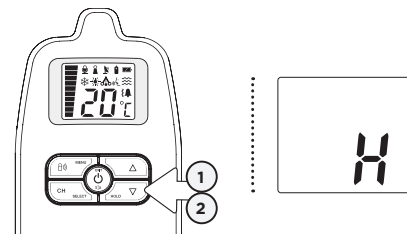

- 1) Press and hold the **Down Volume** arrow for 2 seconds.

The Hold Icon will appear on the screen. The Parent Unit will emit a double beep every minute to remind you that your monitor is on **HOLD**.

- 2) To deactivate this function, press and hold the **Down Volume** arrow for 2 seconds.

#### IMPORTANT

When your monitor is on **HOLD**, the movement-detection feature and movement alarm are disabled.

#### IMPORTANT

When your monitor is in **HOLD** mode, the movement alarm will not go off and the sound will not be transmitted. When your monitor is in Sound only mode, the **HOLD** function cannot be activated.

## 5.9 - TEMPERATURE

### TO ACTIVATE THE TEMPERATURE ALARM:

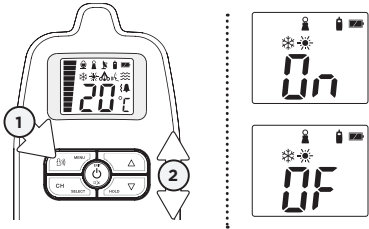

- 1) Press the **MENU** button 5 times.  
The Temperature Indicator (Low and High) will appear.
- 2) Using the arrows, to turn the function ON or OFF.
- 3) Press **SELECT** button to confirm your choice.

### TO SET TEMPERATURE RANGE:

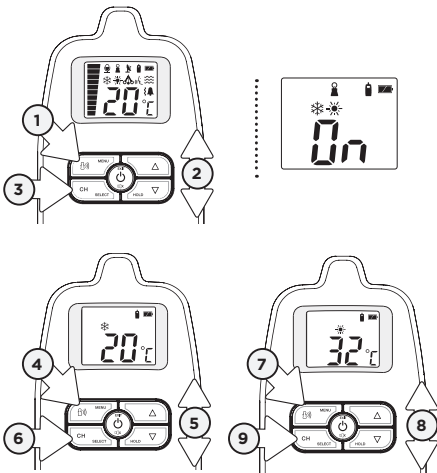

- 1) Press the **MENU** button 5 times.  
The Temperature Indicator (Low and High) will appear.
- 2) Using the arrows, turn the function **ON**.
- 3) Press the **SELECT** button to confirm your choice.
- 4) Press the **MENU** button and the Snow Flake (Low Temperature icon) will appear.
- 5) Press the arrows to set the **LOW** temperature alarm (5 to 19° Celsius)
- 6) Press the **SELECT** button to confirm your choice.
- 7) Press the **MENU** button and the Sun (High Temperature icon) will appear.
- 8) Use the arrows to set **HIGH** temperature alarm (22 to 40° Celsius).
- 9) Press the **SELECT** button and then the **EXIT** button to confirm your choice.

#### TEMPERATURE ALARM

- Alarm activates when the temperature reaches the maximum or minimum set temperature.
- Parent Unit will emit 3 consecutive beeps, every 5 seconds if the temperature reaches levels out of your chosen range. The relevant icon will flash on the Parent Unit screen to alert you.

## YOU ARE NOW READY TO USE YOUR MONITOR

The Angelcare® monitor can be used with the pre-program factory settings or you can also customize your settings to your preference.

### DEFAULT SETTINGS

- Detection Mode:** Sound & Movement
- Temperature Unit:** Celsius
- Temperature Alarm:** OFF  
**Temperature Alarm Setting:**  
High 30 °C  
Low: 19 °C
- Alarm Mode:** Sound Only
- Out of Range:** OFF
- Sound transmission (VOX):** ON

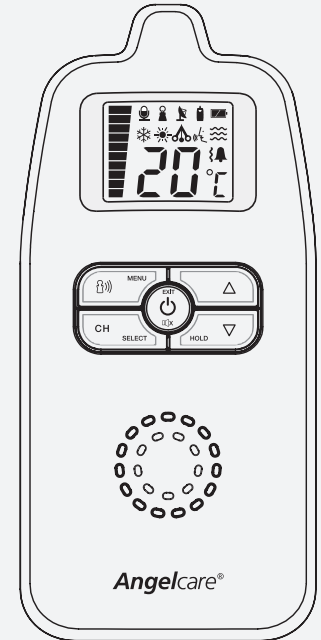

#### IMPORTANT

- Test your monitor before first use.
- Test your monitor regularly to ensure it is functioning correctly.
- Test your monitor every time you move the Sensor Pad to a different place.

## STEP 6 - ACTIVATING AND DEACTIVATING ADDITIONAL FUNCTIONS

The Angelcare® monitor can be used with the pre-program factory settings or you can also customize your settings to your preference.



All changes and adjustments made in the main menu and sub-menu will not be activated unless you confirm them by pressing the **SELECT** button followed by the **EXIT** button.

### IMPORTANT

When in MENU or SUB-MENU mode **NO sound, alarm or vibration** will be emitted from either the Parent Unit or the Nursery Unit even if they were activated before pressing the MENU or SUB-MENU mode.

### 6.1 - PAGER

Allows you to locate the Parent Unit.

#### TO LOCATE THE PARENT UNIT:

Press and release the Nursery Unit **Pager** button on the rear of the Nursery Unit. The Parent Unit will emit a paging sound.



#### TO STOP THE PAGING SOUND:

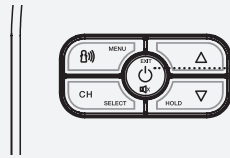

Press the Power button on the Parent Unit

### 6.2 - NIGHT LIGHT

Slide the **Night Light** button on the Nursery Unit to turn it **ON** or **OFF**.

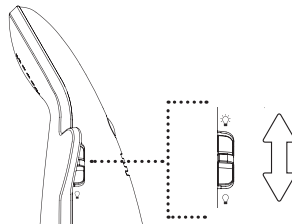

## TROUBLESHOOTING

### TAKING CARE OF YOUR RECHARGEABLE BATTERIES

- Ensure that you fully charge your batteries for 15 hours before their first use.
- To maintain maximum battery life it is recommended that you fully discharge your batteries periodically. Battery performance can be diminished by leaving the batteries constantly charging. If your parent unit is not in use, please turn it off.
- Inadequate battery power can impair the performance of your monitor. If you are not happy with the performance of your Parent Unit/Monitor please replace the rechargeable batteries (3 or 6 x NiMH Rechargeable Batteries).
- It is advisable to change the batteries every 6 months.

### LOSS OF CONNECTIVITY

In the case of loss of connectivity, the first step is to bring the Parent Unit and Nursery Unit closer together and make sure that both units are ON to restore the connection. If there is still no connection and no out of range warning after the above has been done, then and only then should the re-connection procedure below be done.

#### Re-connection procedure:

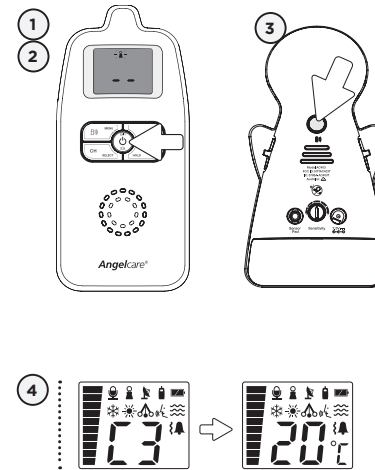

- 1) Turn OFF the Parent Unit and switch it back ON. LCD will only show '—' with back light on and nursery unit icon will flash.
- 2) By pressing and holding for 3 seconds the Parent Unit "MENU/CONNECT" button, the Parent Unit will be set in to connectivity mode (you will hear a beep tone and the antenna icon will flash for 15 seconds).
- 3) To set the Nursery Unit in to connectivity mode, press and hold the Page button for 4 seconds (on the back of the Nursery Unit). The Power LED will light and a beep tone will be emitted as the connection procedure should be completed.

#### NOTE:

If step 3 is not followed within the duration, the Parent Unit will exit the connectivity mode and you will need to start this process again.

- 4) When the Parent Unit and Nursery Unit are connected, the parent unit emits a confirmation tone and will show the channel number which will be replaced by the temperature (normal screen) a few seconds later.

#### NOTE:

If the TIC light is flashing, do not press the "Page" button or the link may be interrupted.

## FALSE ALARMS

- Verify the connection between Sensor Pad and Nursery Unit. Unplug and reconnect the cord.
- Make sure there is no bedding between the mattress and the Sensor Pad.
- If the crib has a spring or slat base, place a hardboard between the crib base and the Sensor Pad measuring at least 33 cm x 33 cm and 6 mm thick.
- Make sure the Sensor Pad is positioned as described under the setup requirements. Sensitivity may need to be adjusted, refer to step 5.3.

## ALARM WILL NOT SOUND

- Avoid contact with the crib when the monitor is ON.
- Place the crib near a solid supporting wall to avoid Sensor Pad from detecting movement from outside the crib.
- You may need to increase the sensitivity, refer to step 5.3.

## NO SOUND IS BEING TRANSMITTED

- Ensure that both units are switched ON.
- Check that the sound has not been turned down on the Parent Unit. Increase the volume level on the Parent Unit, refer to step 5.5.
- Check on the Parent Unit screen to see if the monitor is in temporary MUTE mode instead of ON mode. Deactivate the temporary MUTE function, refer to step 5.6.
- If there is no power to any unit check/replace the batteries, recharge the Parent Unit & check the AC Adaptors are working. Change electrical outlets if required.
- Bring the Parent Unit and Nursery Unit closer together.

## NURSERY UNIT POWER ON INDICATOR (GREEN LIGHT) DOES NOT LIGHT UP

- Turn the switch behind the left wing ON.
- Check connections or change to another electrical outlet.

## WEAK RECEPTION

- Bring units closer together.
- Change the position of one or both units.
- Place units on a flat surface away from baby's reach.
- Replace the batteries or recharge Parent Unit.

## STATIC, DISTORTION, INTERFERENCES (FROM OTHER MONITORS, WIRELESS PHONES, WALKIE-TALKIES, ETC...)

- Rotate the Parent Unit or move it away from source of interference.
- Try a different channel, refer to Step 4.

## FEEDBACK (LOUD NOISES EMITTED FROM THE PARENT UNIT)

- Move the units farther apart (at least 3 meters apart).
- Decrease the volume on the Parent Unit.

## THE PARENT UNIT SCREEN IS BLACK (PARENT UNIT IS OFF)

- Turn the Parent Unit back ON by pushing and holding the power button.
- Replace the batteries or recharge the Parent Unit.

If you experience a problem that is not noted in this manual, please do not return the product to the store. If you are not completely satisfied or have any questions:

**United States and Canada:** please contact us at: [angelcare@cdecinc.ca](mailto:angelcare@cdecinc.ca)

**Other countries:** please contact your local Distributor.

We may have a simple solution to your problem.

## LIMITED WARRANTY

Angelcare® warrants to the original owner of this product that Angelcare® rechargeable, movement and sound monitor (model AC403) is free from any material and workmanship defects, for a period of one (1) year (rechargeable batteries not included) from the date of the original purchase. If this monitoring system fails to function properly when used as directed under normal conditions within the one year period, Angelcare® will either repair or replace the product, at our discretion, free of charge. Please contact your distributor.

The product must be accompanied by a proof of purchase, either a bill of sale or other proof that the monitoring system is within the warranty period. Angelcare® will bear the cost of repairing or replacing the product and shipping it back to you.

**This warranty does not apply to a product which has been damaged as a result of improper maintenance, an accident, improper voltage supply or any other form of misuse. The warranty is also void if the owner repairs or modifies the product in any way. Angelcare® is not liable for any incidental or consequential damages with regard to this product. The warranty also excludes any liability other than what is stated above. No other warranty is given.**

LEGAL RIGHTS VARY FROM COUNTRY TO COUNTRY. SOME COUNTRIES DO NOT ALLOW THE EXCLUSION OR LIMITATION OF INCIDENTAL OR CONSEQUENTIAL DAMAGES, SO THE ABOVE LIMITATIONS MAY NOT APPLY TO YOU.

WE ARE NOT IN ANY WAY RESPONSIBLE FOR ANY OUTCOME RESULTING FROM THE USE OF THIS PRODUCT.

## IMPORTANT!

This Angelcare® monitor is a personal care product. Please do not return this product to the store. If you have questions or need help, please call your distributor before returning this product.







This Angelcare Baby Monitor is a Personal Care Product. **Please DO NOT return this to the store**, but contact us initially for advice and assistance:

**Angelcare Helpline** on **0845 009 1789**

**Website:** [www.angelcare.co.uk](http://www.angelcare.co.uk)

**Email:** [helpline@babyhelpline.co.uk](mailto:helpline@babyhelpline.co.uk)

NOTE: Helpline is open Monday to Friday, 10am to 4pm, excluding bank holidays.

